

THE FEATURE ORIENTED PHONE SYSTEM FOR EVERY HOME

With exclusive Emergency Help System
you can Call-4-Help with a press of a button

Hear who is calling
before you decide to answer an incoming phone call*

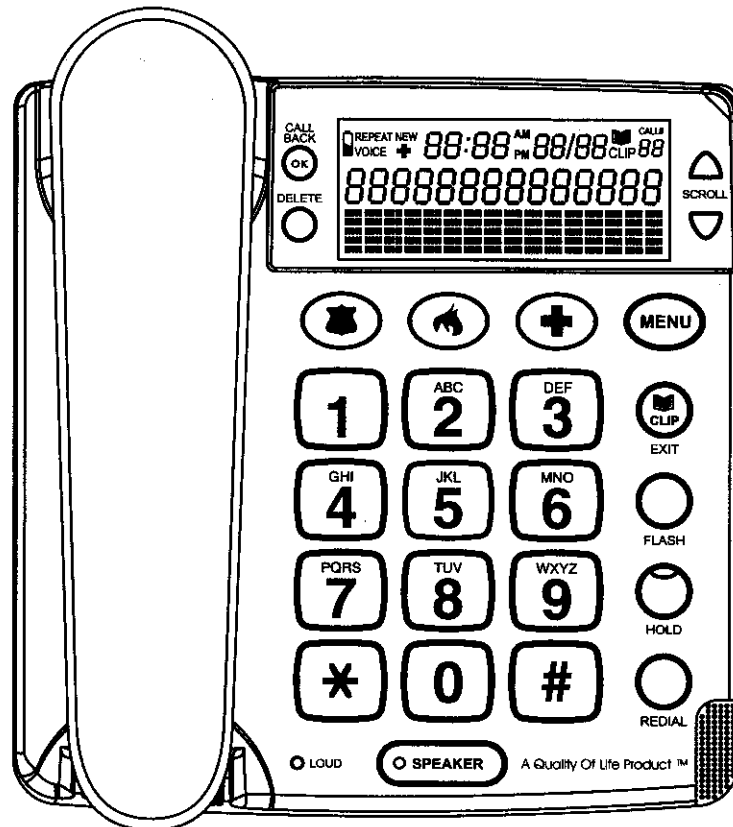

Answer your phone and speak hands-free
even if you can't get to the phone**

USER MANUAL	ClearVoice 50 A™	501013
	ClearVoice 100 A™	501017
	ClearVoice 200 A™	501016



Consumer Helpline **1-888-558-7420**

TABLE OF CONTENTS

Important Safety Instructions	2
Safety Instruction for Batteries	2
Installation Instructions	2
Important Notes	3
FCC Wants You to Know	3
Service	4
General Information	4
About Your Unit	4
Location of Controls	5
Installation	6
Where to install this feature-oriented telephone / Installing batteries / To replace the battery of the remote pendant: ClearVoice 100A™ and ClearVoice 200A™ / Choose your location / Connecting the ClearVoice 50A, 100A or 200A / Wall Mounting	
Special highlight Features	8
Setting Up to Use All the Features of Your Unit	9
Setting the language / Setting the LCD contrast / Setting the TIME and DATE / Setting the Tone/Pulse / Setting the Ringer Tone / Setting the Voice ON/OFF / Ringer Volume Control / Handset Volume Control/Tone Receiving Adjustment	
Using the Telephone	12
Dialling a Call / Pre Dialling a Call / Receiving a Call / Speaker Volume Control / Redial / Pause / Hold / Flash / Hearing Aid Compatibility / Important Features of your telephone / Phone Book / Storing up to 30 telephone numbers in the phone book including emergency nos. to be called in an emergency / To review the Phone Book Memory / To dial the displayed telephone number of Phone Book Memory / Recording/Editing/Deleting voice prompt of name of phone book / To Edit the Phone Book Memory / To Delete the Phone Book Memory	
Emergency Features	17
Emergency Help System / Emergency Message / Phone Book (Emergency Nos.) / To review the Phone Book Memory / To dial and check a displayed emergency telephone number from the Phone Book Memory / Recording/Editing/Deleting voice prompt of name of phone book / To Edit the Phone Book Memory / To Delete the Phone Book Memory / To Store Numbers hotkey  and  / To Activate the Emergency Help System / Important Information about ClearVoice 50,100 or 200 Emergency Help System / Checking the Range of the Dual Wireless Help Pendant (CV 112)	
The Caller ID	24
Receiving a Call (the telephone can store up to 64 calls) / Viewing the Caller ID Memory / Erase the Caller ID Memory / Call Back (Redial) from the Caller ID Memory / Copy from the Caller ID to the Phone Book / Important Review	
In Case of Difficulty	26
Limited Ninety-Day Warranty	27

IMPORTANT SAFETY INSTRUCTIONS

When using your telephone equipment, basic safety precautions should always be followed to reduce the risk of fire, electric shock and injury to persons, including the following:

1. Do not use this product near water, for example, near a bath tub, wash bowl, kitchen sink or laundry tub, in a wet basement or near a swimming pool.
2. Avoid using a telephone (other than a cordless type) during an electrical storm. There may be a remote risk of electric shock from lightning.
3. Do not use the telephone to report a gas leak in the vicinity of the leak.
4. Use only the power cord and batteries indicated in this manual. Do not dispose of batteries in a fire. They may explode. Check with local codes for possible special disposal instructions.
5. Plug the adaptor to the socket-outlet that near the equipment and shall be easily accessible.

SAVE THESE INSTRUCTIONS

SAFETY INSTRUCTION FOR BATTERIES

CAUTION:

TO REDUCE THE RISK OF FIRE OR INJURY TO PERSONS, READ AND FOLLOW THESE INSTRUCTIONS.

1. Use only 4 x AA alkaline battery. Pendant uses a 12V alkaline battery.
2. Do not dispose of the batteries in a fire. The cell may explode. Check with local codes for possible special disposal instructions.
3. Do not open or mutilate the battery. Released electrolyte is corrosive and may cause damage to the eyes or skin. It may be toxic if swallowed.
4. Exercise care in handling battery in order not to short the battery with conduction materials such as rings, bracelets and keys. The battery or conductors may overheat and cause burns.
5. Do not attempt to recharge the battery identified for use with this product. The battery may leak corrosive electrolyte or explode.
6. Do not attempt to rejuvenate the battery identified for use with this product by heating them. Sudden release of the battery electrolyte may occur causing burns or irritation to eyes or skin.
7. When inserting battery into this product, the proper polarity or direction must be observed. Reverse insertion of the battery can cause charging, and that may result in leakage or explosion.
8. Remove the battery from this product if the product will not be used for a long period of time (several months or more) since during this time the battery could leak in the product.
9. Discard "dead" battery as soon as possible since "dead" battery are more likely to leak in a product.
10. Do not store this product, or the battery identified for use with this product, in high-temperature areas. A battery that is stored in a freezer or refrigerator for the purpose of extending shelf life should be protected from condensation during storage and defrosting. The battery should be stabilized at room temperature prior to use after cold storage.

SAVE THESE INSTRUCTIONS

INSTALLATION INSTRUCTIONS

1. Never install telephone wiring during a lightning storm.
2. Never install telephone jacks in wet locations unless the jack is specifically designed for wet locations.
3. Never touch uninsulated telephone wires or terminals unless the telephone line has been disconnected at the network interface.
4. Use caution when installing or modifying telephone lines.

NOTE: Refer to "FCC Wants You To Know" section before connection to telephone.

IMPORTANT NOTES

- The telephone portion of your dialer/message console has been tested and found to comply with all applicable UL and FCC standards.
- This product is not a security system or an emergency service device.
- The manufacturer makes no claim as to the suitability of this product to perform as a life-saving device. See section marked LIMITED NINETY DAY WARRANTY for full warranty conditions.
- The unit will not work through a switchboard, some phone systems that don't always supply a standard dial tone or phone systems that require a delay, (for example, some systems where you must dial a number to get an outside line). For more information, call 1-888-558-7420.

FCC WANTS YOU TO KNOW

This equipment complies with Part 68 of the FCC rules and the requirements adopted by the ACTA. On the bottom of this equipment is a label that contains, among other information, a product identifier in the format US:AAAEQ##TXXXX. If requested, this number must be provided to the telephone company.

An applicable certification jacks Universal Service Order Codes (USOC) for the equipment is provided (i.e., RJ11C) in the packaging with each piece of approved terminal equipment

The REN is useful to determine the quantity of devices you may connect to your telephone line and still have all of those devices ring when your telephone number is called. In most, but not all areas, the sum of the REN's of all devices connected to one line should not exceed five (5.0). To be certain of the number of devices you may connect to your line, as determined by the REN, you should contact your local telephone company to determine the maximum REN for your calling area.

If your telephone equipment causes harm to the telephone network, the telephone company may discontinue your service temporarily. If possible, they will notify you in advance. But if advance notice isn't practical, you will be notified as soon as possible. You will be informed of your right to file a complaint with the FCC.

Your telephone company may make changes in its facilities, equipment, operations or procedures that could affect the proper functioning of your equipment. If they do, you will be notified in advance to give you an opportunity to maintain uninterrupted telephone service. If you experience trouble with this telephone equipment, disconnect from the network until the problem has been corrected or until you are sure that the equipment is not malfunctioning.

This equipment may not be used on coin service provided by the telephone company. Connection to party lines is subject to state tariffs

Warning: Changes or modifications to this unit not expressly approved by the party responsible for compliance could void the user's authority to operate the equipment.

NOTE: This equipment has been tested and found to comply with the limits for a Class B digital device, pursuant to Part 15 of the FCC Rules. These limits are designed to provide reasonable protection against harmful interference in a residential installation. Some telephone equipment operate at frequencies that may cause interference to nearby TV's and VCR's; to minimize or prevent such interference, the base of telephone equipment should not be placed near or on top of a TV or VCR; and, if interference is experienced, moving the telephone equipment farther away from the TV or VCR will often reduce or eliminate the interference. However there is no guarantee that interference will not occur in a particular installation. If this equipment does cause harmful interference to radio or television reception, which can be determined by turning the equipment off and on, the user is encouraged to try to correct the interference by one or more of the following measures:

- Reorient or relocate the receiving antenna.
- Increase the separation between the equipment and receiver.
- Connect the equipment into an outlet on a circuit different from that to which the receiver is connected.

- Consult the dealer or an experienced radio TV technician for help.

- a) A plug and jack used to connect this equipment to the premises wiring and telephone network must comply with the applicable FCC Part 68 rules and requirements adopted by the ACTA. A compliant telephone cord and modular plug is provided with this product. It is designed to be connected to a compatible modular jack that is also compliant. See installation instructions for details.
- b) **NOTICE:** If your home has specially wired alarm equipment connected to the telephone line, ensure the installation of this telephone does not disable your alarm equipment. If you have questions about what will disable alarm equipment, consult your telephone company or a qualified installer.

Telemergency Ltd.
200-16B2 13th Avenue
Ronkonkoma, N.Y. 11779
Telephone: (631) 467-6700

SERVICE

According to FCC regulations, this equipment, which has been certified and registered by the FCC, may only be repaired by authorized persons. If repairs or adjustments are made by an unauthorized person, the FCC certification may be voided. Should you encounter any problems, please call the toll-free Consumer Helpline for assistance:
1-888-558-7420, 9:00 am - 4:30 pm (E.S.T.)

Any Questions?

STOP...don't take unit back to the store.

Call our toll-free number... 1-888-558-7420

Listen as our experts talk you through the problem

GENERAL INFORMATION

UNPACKING

This package contains:

- ClearVoice 50, 100 or 200
- Accessory: Wireless remote pendant CV111 (for ClearVoice 100™ only)
- Accessory: Wireless dual remote pendant CV112 (for ClearVoice 200™ only)
- One Quick Instruction Guide
- One AC Adaptor
- One modular Line Cord
- User Manual/Warranty Information

If anything is missing or damaged, contact us at 1-888-558-7420. Keep the package to transport unit. For your reference keep a record of date of purchase and code number on the pendant. Please keep the sales receipt for warranty reference.

Date of Purchase _____

ABOUT YOUR UNIT

The following important features are included..amplified handset, dial a number from memory, dial a number from its phone book, can let you listen to who is calling you if you have Caller ID service, use as a standard speakerphone, use to Call-4-Help in an emergency, can be used as a speakerphone remotely (optional on ClearVoice 50) even if you can't get to the phone plus much more. ClearVoice Models 50, 100 and 200 can even offer full usage of these features for up to 12 hours of power failure(s).

INSTALLATION

Where to install this feature-oriented telephone

When installing this feature-oriented telephone, consider that the unit should be placed in an area of common use during the day and night time.

ClearVoice 200A™ users should locate the phone within 10-15 feet line of sight from where user spends a lot of time. The remote pick-up can be from a distance far greater than the 10-15 feet. This allows users the remote speakerphone features of the unit plus remote activation of the Emergency Help System™, for those who may not easily get to the telephone or are concerned with falling.

ClearVoice 100A™ users should locate the phone within 10-15 feet from where they spend a lot of time. This allows them to use the remote speakerphone features of the unit. ClearVoice 100A™ users can purchase the remote activation of the Telemergency Emergency Help System by calling the consumer helpline @ 1-888 558-7420.

ClearVoice 50A™ can purchase an optional accessory to include the remote features of each these units remotely by calling the Consumer Helpline 1 888 558 7420.

Installing batteries

Your telephone requires four AA batteries (not supplied) if you wish to utilize all features during power failures. During power failures, full functionality of the telephone is maintained for a total of a maximum of 12 hours total power failure time. If you do not have batteries installed the basic phone function of calling out and receiving a call can still be used.

Note: The telephone numbers in memory and the voice recordings are stored in non-volatile flash memory which do not require battery backup.

Before opening the battery compartment, make sure the telephone is disconnected from the telephone line and the 120V AC Adaptor is disconnected from the unit.

1. Use a flat-blade screwdriver to lift the battery compartment door.
2. Insert four AA alkaline batteries into the compartment as indicated by the polarity symbols.
3. Snap the battery compartment door back into place.

Note: If  appears on the display or the display dims, replace the batteries with 4 new alkaline AA batteries to assure maximum power failure time.

To replace the battery of the remote pendant: ClearVoice 100A™ and ClearVoice 200A™

The pendant is equipped with a pre-installed internal battery.

1. Use a screwdriver to remove the screw on the lower case of the pendant and remove the lower case.
2. Replace the 12V DC Alkaline battery with a fresh one.
3. Replace the lower case and secure it with the screw.
4. It is important that full functionality be checked out after replacing battery.

Choose your location

Your ClearVoice 50A, 100A or 200A must be placed on a hard surface and connected to both the telephone wall jack and an AC power source. Allow at least one inch to the rear and four inches above the unit for ventilation. If you have a ClearVoice 100A or 200A, we suggest you locate it in a location within 10 feet of where user spends much of his time.

For users of ClearVoice 100A or 200A: You can activate the speakerphone on an incoming call of the ClearVoice 100A or 200A remotely. You can typically speak from up to 10-15 feet from the phone which should be in direct line of sight. Speaking louder can allow you to speak up to 20 feet, line of sight.

For users of ClearVoice 200A: The ClearVoice 200A is supplied with a dual pendant which can activate the speakerphone, but also can activate the emergency mode from a distance of up to 80 feet. This range may be reduced by structural or environmental conditions.

For users of ClearVoice 50A and 100A: You can purchase accessory(s) which can activate both the speakerphone for incoming calls as well as activating the Emergency Help System.

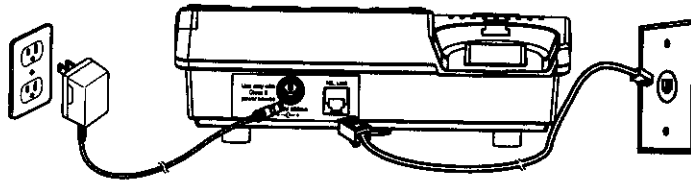

To retain full operation of ClearVoice 50A, 100A and 200A, during power failures insert 4 AA batteries (not included) into the battery compartment located at bottom of unit. You may do this by simply disconnecting the AC adaptor from the power source, then removing the battery cover, connecting the batteries and replacing the cover. Then immediately connect AC Adaptor to AC outlet to assure battery life is not being affected. Note: The AA batteries should be alkaline.

Connecting the ClearVoice 50A, 100A or 200A:

1. A. Plug one end of the supplied telephone cord into the jack labeled TEL LINE located at the back of the unit.
B. Plug the other end of the supplied modular cord into the telephone wall jack.
2. A. Plug the supplied power cord of the AC Adaptor into the jack labeled DC9V 200ma located on the back of the unit.
B. Plug the other end of the power cord into an electrical outlet **not controlled by a wall switch**.

Wall Mounting

On a Wall Phone Plate

1. Press and lift out the handset holder. Rotate it 180°, and snap it into place so it will hold the handset in place when the phone is mounted on the wall.
2. Insert the mounting bracket's two tabs into the matching slots opposite the keyhole slot on the underside phone's base. Then press down and slide the bracket upward until the tabs snap into place.
3. Plug one end of the supplied short modular cord into the LINE jack at the back of the base.
4. Plug the cord's other end into the wall plate jack, then align the base's keyhole slots with the wall plate studs and slide the phone downward to secure it.

On a Wall Without a Plate

To mount the phone directly on a wall, in addition to the preceding steps, you need two screws (not supplied) with heads that fit into the keyhole slot on the bottom of the base.

1. Drill two holes 83mm apart (vertically). Then thread a screw into each hole, letting the heads extend about 5mm from the wall.
2. Substitute the long modular cord for the short cord.

SPECIAL HIGHLIGHT FEATURES

The Phone that can tell you who is calling

The Phone that can answer a call remotely (ClearVoice 100A and 200A only)

The Phone that can get you emergency help with a press of a button

Talking Caller ID* – allows user to hear # calling or name

Remote Pickup (Clearvoice 100A and 200A)** – allows user to answer incoming call remotely

Remote Speakerphone (ClearVoice 100A and 200A)** – allows user to speak hands-free remotely up to 20 feet

Emergency Help System (EHS) – with a press of a button on unit can call emergency #s you entered.

Remote activation of Emergency Help System (EHS)*** – CV112 pendant can activate the EHS from a distance of up to 100 feet depending upon structural and environmental conditions

LCD display – shows last 64 nos. called, time and date and prompts to simplify usage

Voice Clarity (Amplified/tone control) – handset volume/tone adjust to improve clarity of call for hearing impaired

Amplified Ringer – loud ringer

Phone Book memory – holds up to 30 telephone numbers in phone book memory..for general/important #s and getting emergency help,

Big Button keypad – for easy dialing (for easy dialing and for those having difficulty seeing or using the keypad). Hear the telephone digits being entered.

Easy to Use – Voice Prompts for easy programming.

*Caller ID service required

**CV111(silver) or CV112(white) pendant required

***CV112 pendant required

Please read this section prior to using the important features of your ClearVoice 50A,100A or 200A.

Symbols you should know:

OK is also used for **CALL BACK**

MENU is also used for **EDIT**

CLIP is also used for **EXIT**

SETTING UP TO USE ALL THE FEATURES OF YOUR UNIT

Note: Your unit has many VOICE PROMPTS to assist you

The following features can use Voice Prompts or prompts on the LCD display on your unit

Setting the LCD contrast

Setting the Time and Date

Settings for Tone /Pulse operation- preset to tone

Setting the Ringer Melody (select the type of sound of the Ringer)

Setting the language (English or Spanish)-preset to English

Setting the Voice ON/OFF (preset to Voice)

Ringer Volume Control

Handset Volume Control

Lets get started:

Important: In setting the following criteria, if there is a delay in programming a specific feature of more than 60 seconds, your unit will reset. In that event please re-enter the section you are entering.

Setting the language

Note: This unit has a voice menu as well as a prerecorded emergency message that can display and/or speak its messages in English or Spanish. **Your unit is set to English.** Skip this section if you wish to continue usage in English by pressing EXIT button.

This telephone is able to write on the LCD and to give you a voice guide in two different languages. By selecting the language the user will automatically select both the voice and the written LCD language.

1. Press and release the **MENU** button until **LANGUAGE** is shown.
2. Press the **OK** button, the display shows **ENGLISH** (for example).
3. Select the desired language scroll the Δ or ∇ buttons. Confirm with **OK** button. Unit will say Language..
4. Press \boxtimes (Exit) button to exit this set-up mode.

Setting the LCD contrast (If LCD contrast is OK, press Exit button)

Depending on the viewing angle of the telephone, the user may want to adjust the LCD contrast:

1. Press and release the **MENU** button. The display shows **LCD CONTRAST**.
2. Press the **OK** button (located upper front left. The display shows the current contrast setting with values between 1 and 5.
3. Press Δ or ∇ buttons (upper front right) and scroll until desired contrast to select the contrast level.
Confirm with OK button again. Unit will say TIME/DATE.
4. Press \boxtimes (Exit) button to exit this set-up mode.

Setting the TIME and DATE

1. Press and release the **MENU** button until **TIME/DATE** is shown.
2. Press the **OK** button. The display shows **ENTER TIME** and the hour digit is flashing.
3. Select the current hour scrolling \triangle or ∇ buttons and scroll to the present hour and confirm with **OK** button. The minutes will now flash in the display.
4. Select the required minutes scrolling \triangle or ∇ buttons and scroll to the present minute. Press the **OK** button.
The display now shows **ENTER DATE** and the month digit is flashing. .
5. Select the current month scrolling \triangle or ∇ buttons and scroll to the present month. Confirm with **OK** button. The day will now flash in the display.
6. Select the current day scrolling \triangle or ∇ buttons and scroll to the present date. Confirm with **OK** button. Unit will say **STORE NO. TO PHONE BOOK**.
7. Press \blacksquare (Exit) button to exit this set-up mode.

Important: If you have subscribed to Caller ID service, please note that some telecom providers, when sending the Caller ID signal also send the time and date. In this case the telephone will automatically set its internal clock.

Setting the Tone/Pulse

Important: Your unit is already preset to TONE. If you have a tone dialing phone and tone dialing service, skip this step by pressing the Exit button.) If you have a rotary dialing system in your home, follow these instructions.

1. Press and release the **MENU** button until **TONE/PULSE** is shown.
2. Press the **OK** button, the display shows **TONE**.
3. Select the **TONE** or **PULSE** by scrolling \triangle or ∇ buttons.
Confirm with **OK** button. Unit will say **TONE/PULSE**.
4. Press \blacksquare (Exit) button to exit this set-up mode.

Setting the Ringer Tone

Note: Your unit is preset to a Ringer tone. (If you do not wish to change press the Exit Button) To change..follow these steps.

1. Press and release the **MENU** button until **RINGER TONE** is shown.
2. Press the **OK** button, the display shows **1**.
3. You can select ringer **1**, **2**, or **3** by scrolling \triangle or ∇ buttons.
Confirm with **OK** button. Unit will say **LANGUAGE**.
4. Press \blacksquare (Exit) button to exit this set-up mode.

Setting the Voice ON/OFF

The telephone is factory preset with all voice features **ON**. (To exit, press Exit button)

Note: The volume of the voice features is regulated through the SPEAKER VOLUME slide switch located on the side of unit.

Important: If using the voice prompts or speakerphone, it is important to slide switch to the middle.

If the user does not wish to hear the voice prompts, this voice feature can be set to OFF. We suggest that while programming you keep this feature ON.

1. Press and release the **MENU** button until **VOICE** is shown.
2. Press the **OK** button.
3. Scroll the Δ or ∇ buttons to select between **VOICE ON** or **OFF** and confirm with **OK** button. Unit will say VOICE ON/OFF.
4. Press \times (Exit) button to exit this set-up mode.

Ringer Volume Control

The ringer sound level can be adjusted by sliding the RINGER switch located on the side of the unit to select high (HI), mid (MID) and low (LO) level.

The red bright LED on front of unit will flash with all incoming calls.

Handset Volume Control/Tone Receiving Adjustment

The HANDSET volume control located under the handset enables user to adjust the amplification of the call which will also result in a more comfortable listening level. To turn on this amplifier after you pick up the handset...press \oplus button on telephone for 1 second and release, LOUD LED display will now be lit. Move handset volume control to desired amplification. Move TONE level, located on side of unit to desired level. Your unit is now set to your desired level as long as the settings are kept. Each time you hang the handset up, the amplifier will go OFF. Each time you pick up the handset, simply press the \oplus button for 1 second to turn on the amplifier. To turn off amplifier and tone level simply press \oplus button for 1 second. LOUD LED will also go OFF.

USING THE TELEPHONE

Dialling a Call

1. Pick up the handset or press **SPEAKER** button (the speaker LED will light) and wait for a dial tone.
2. Press the keypad for the telephone numbers you wish to dial. The display will show the number that you dialed on the keypad. If you dial a number over 14 digits long, it will show the last 14 digits only.
3. When you have completed your call, hang up the handset, or press **SPEAKER** button again.

To switch from a handset conversation to a speakerphone conversation press the **SPEAKER** button and hang up the handset. To switch from speakerphone to handset, simply pick up handset.

Pre Dialing a Call (Hearing each digit entered before dialling)

1. Dial on the keypad the telephone number. The telephone will voice the digits dialed (with voice option ON). To correct a number press the **DELETE** button for each incorrect digit.
2. Pick up the handset or press **SPEAKER** button.

Receiving a Call

When you receive a call, the telephone rings, the Ringer LED flashes and the display shows the CALL# and the caller telephone number, and will state the name of the caller if the number matches with a name recorded in the phone book, if not, it will say the numbers of the calling party if available (Caller ID service required). Caller ID service required to detect Call# and/or name of caller.

This feature allows you to decide to pick up the phone or not depending on who is calling.

If you want to talk to the caller:

1. Pick up the handset or press **SPEAKER** button to answer the call.
2. At the end of the call, return the handset to the cradle or press **SPEAKER** button again to disconnect..

Receiving a Call/Speakerphone remotely (Models 100A and 200A)

Simply press the red button on the CV111 or CV112 pendant for 1 second to connect the call and activate its speakerphone if you hear the phone, but can't get to the telephone.

When you are near the speakerphone you can begin speaking to the caller without picking up the handset.

To terminate the call, press the red button again for 1 second.

Note: A feature is included if you activated the speakerphone with the wireless pendant (ClearVoice 100A or 200A pendant), and forgot to disconnect the phone. In this way, the speakerphone can turn OFF. After 15 minutes, the phone will beep for 7 seconds. If within these 7 seconds the called party presses any numeric key on the phone, the unit will be kept in speakerphone mode conversation for 1 minute continuously. If no numeric key on the phone is pressed during the 7 seconds, the telephone will deactivate the speakerphone and return to standby mode unless you pick up your handset on the ClearVoice 100A or 200A to continue.

This convenience feature is particularly useful if you are sitting on a couch, busy doing something else, can't get to the phone on time and don't want to miss the call.

Speaker Volume Control

You can adjust the speaker volume for a more comfortable listening level by sliding the **SPEAKER VOLUME** switch.

This will also adjust the volume of the voice driven features. It is suggested to maintain the volume at medium level.

Redial

Note: To redial the last number called.

1. Lift the handset or press **SPEAKER** button.
2. Press the **REDIAL** button.

Noted: The last number dialed (up to 32 digits long) can be redialed.

Pause

You can insert a 3.6 seconds which will create a pause into dialing or storing a number into memory in order to access custom services and possible short delays in getting dial tone.

Press **REDIAL** button at the desired point in number. Press **REDIAL** button again if an additional 3.6 seconds is needed.

Hold

To place a call on hold, press **HOLD** button. The hold indicator will light. To return to the call, press the **SPEAKER** button (or lift the handset), the **HOLD LED** goes off.

Flash

Many special network services, such as Call Waiting, require a switch hook signal. The **FLASH** button provides the electronic equivalent of a switch hook operation.

For example, if you subscribe to Call Waiting*, you can use this feature to answer another call on the same line by simply pressing the **FLASH** button on the unit. Press the **FLASH** button to return to the first call.

- Please note that a subscription may be required to use these services.

Hearing Aid Compatibility

This unit is compatible with inductively coupled hearing aids.

Important Features of your telephone

Note: The telephone has features that can be very important and convenient to use. This telephone has features that can be a substantial aid for those who are hearing and/or sight impaired, having the ability to get help if there is an emergency in the home, letting you know who is calling, on incoming calls answering and speaking to callers if desired, screening a call before answering, letting you know who called with the ability to call back easily if desired.

PHONE BOOK

Note: The phone book allows you to enter, display, record the persons name and specify if this a telephone no. that is to be called in the units Telemergency Emergency Help System.

To use the phone book, press **EXIT** (Exit) button until the **PHONE BOOK** icon is displayed.

Storing up to 30 telephone numbers in the phone book including emergency nos. to be called in an emergency.

Note: It is suggested that up to 10 telephone nos. be reserved for the emergency function. See Emergency Features in this User Manual. Therefore we suggest you enter up to 20 telephone numbers and names in the General /Important Telephone Numbers.

Entering telephone numbers and names:

Note: If you have a telephone system where it is may be required to put a pause (P) before dialing a particular digit press the REDIAL button and a 3.6 second pause will be created. This is also important if you are using on a PABX or PBX where you insert a pause before and after entering 1,8 or 9, or other systems where outside line dial tone can be delayed.

1. Press and release the **MENU** button until **STORE NUMBER** is shown.
2. Press the **OK** button. The cursor will flash in the first position.
3. Enter the required telephone number with a maximum of 22 digits using the number pad and confirm with **OK** button, (both the erase feature and pause feature can be used when storing the telephone number), telephone numbers are to be entered exactly as you would dial the telephone no. manually from where the ClearVoice model is to be used.
4. Enter the required name with a maximum of 16 letters. Cursor shown as (I) is all the way on left side. See Table 1 for details.
5. Confirm with **OK** button. The display now shows **EMERGENCY OFF**.
6. Press **OK** button.

SAVED is shown and the unit announces "Name Recording for phone book". That means the phone number is stored only for a general phone dial out, but not for emergency's call dial out.

To record voice (example 'this is John'), hold down **OK** button, immediately speak clearly into microphone after a beep and "VOICE" icon is flashing on LCD display.. Release the button when you finished or the unit will stop recording after 3 seconds. The voice prompt will then be played automatically. [Recording the Voice is necessary for the personalized talking Caller ID and talking phone book feature].

You can repeat steps 1 to 6 to enter more numbers or press **EXIT** (Exit) button to exit.

How to enter names in the phone book

The number buttons are also inscribed with letters for entering the name. **By repeatedly pressing the appropriate button, upper case letters as well as numbers and special characters can be entered.**

Overview: Note: In entering a name

Note: The numeric keys 1 thru # can be used as shown in Table 1

1	space + & - / 1
2	A B C 2
3	D E F 3
4	G H I 4
5	J K L 5
6	M N O 6
7	P Q R S 7
8	T U V 8
9	W X Y Z 9
0	, . : ; ? 0
*	' @ () *
#	\$ _ % ! #

Example:

To enter the name JIM. Press 5 button until **J** is displayed Wait 2 seconds
Press 4 button until **I** is shown Wait 2 seconds
Press 6 button until **M** is shown Wait 2 seconds

TABLE I

Notes: Incorrect entries can be deleted with **DELETE** button. To do this, move the cursor the correct position using Δ or ∇ buttons and then press **DELETE** button.

If you wish to place a pause in a telephone number...press redial button and a P will display.

To review the Phone Book Memory

1. Press and release \blacksquare (Exit) button, \blacksquare phone book icon should be shown.
2. Review the stored phone number by scrolling Δ or ∇ buttons, or enter the initial letter of the name of the person you wish to call using the number pad. After a short time, the display will show the first stored telephone number with this initial letter, say the name and VOICE icon is shown if it was recorded, or voice the telephone number. You can now search for further numbers under this letter by scrolling ∇ .

Notes:

- If no telephone number is stored, the display will show **EMPTY**.
- After you view all the call in memory, the display will show **END OF LIST**.
- If a reviewed number is shown with \blackplus icon on the LCD display.. that is one of the numbers that can be dialed if the emergency help system (+) has been activated.

To dial the displayed telephone number of Phone Book Memory:

1. Select a desired telephone number from "To review the Phone Book Memory" above.
2. Press **OK** (Call Back) button.

Recording / Editing / Deleting voice prompt of name of phone book

With caller ID service activated, when an incoming call is received, the unit will display and announce the caller's phone number, If the caller's phone no. and name recording in the phone book, matches the last 7 digits of the incoming tel. no., the recorded voice prompt for that no will be announced. If the voice prompt is recorded for this phone number, the unit may announce the voice prompt recorded.

Note: For name to be announced on an incoming call, the phone book entry tel. no. must match exactly.

1. Press and release the **MENU** button until the "**NAME RECORDING**" is shown.
2. Press the **OK** button. A list of the phone book entries will be displayed.
3. Scroll Δ or ∇ buttons to select the list you like to record a voice or name for it.
4. To record or edit the voice prompt, hold down **OK** button. Speak clearly into the microphone after a beep and "VOICE" icon is flashing. Release the button when you finished or the unit will stop recording after 3 seconds. The new voice prompt will then be played automatically.

To delete the voice prompt recorded, press **DELETE** button during the voice prompt is playing.

5. Repeat step 3 to 4 to edit or delete more entry or exit the set-up mode by pressing the \blacksquare (Exit) button.

To Edit the Phone Book Memory

1. Press and release **⏏** (Exit) button, **☎** phone book icon is shown.
2. Select the required location from the phone book by scrolling **△** or **▽** buttons.
3. Press and hold **MENU** button for two seconds. The display will show **EDIT?**.
4. Press **OK** button, the first digit of the selected phone number will be flash.
5. You can move the cursor to the required position by scrolling **△** or **▽** buttons. To delete the digit, press **DELETE** button, or press any numeric key to replace the digit and confirm with **OK** button. Then the display shows the flashing first letter of the name.
6. Move the cursor to the required position by scrolling **△** or **▽** buttons. To delete the letter, press **DELETE** button, or press any numeric key to replace the name. Confirm with **OK** button, "**EMERGENCY ON or OFF**" is shown.
7. If the display shows "**EMERGENCY OFF**", and you want to change it as an emergency's call dial out, select "**EMERGENCY ON**" by scrolling **△** or **▽** buttons. Confirm with **OK** button, now "**LOCATION**" is shown. Select the required location by scrolling **△** or **▽** and confirm with **OK** button, if the location is in use, now display shows **OVERWRITE?**, confirm with **OK**, "**SAVED!**" is shown. If you select "**EMERGENCY OFF**" and confirm with **OK**, "**SAVED!**" is shown.
8. You can repeat step 2 to 7 to edit more numbers or press **⏏** Exit button to exit.

To Delete the Phone Book Memory

1. Press and release **⏏** (Exit) button, **☎** phone book icon is shown.
2. Select the required location from the phone book by scrolling **△** or **▽** buttons.
3. To delete single memory, press **DELETE** button once. The display will show the **DELETE?**. Press **DELETE** button for 2 seconds. The telephone number and name will be deleted and the display will now show another number from the phone book.
To delete all entire memory, press and hold **DELETE** button until the display shows **DELETE ALL?**. Press **DELETE** button for 2 seconds until **EMPTY** appears on the display.

EMERGENCY FEATURES

EMERGENCY HELP SYSTEM

This feature allows you to Call-4-Help from those people you would like called in an emergency. For the Emergency Help System to be activated and also dial out the emergency telephone numbers entered in the sequence you would like the telephone nos. called, requires that the telephone line ClearVoice 50A, 100A, or 200A is connected to is ON HOOK(hung up) and all instructions in setting up have been done.

Emergency Message

It is important you record the personalized message with all the important information as in B. below.

- A. Your unit includes a back-up pre-recorded message "This is an emergency call, to accept this call press zero".
- B. Your own message that must be recorded to properly use the Emergency Help System (max. recording time is 20 seconds). The message must always end with "please immediately hang up if you cannot get me help now.. To accept this call press zero".

Example: There is a medical emergency at the home of John Smith at 123 Main Street, Apt. 4D, please come @ once. Please immediately hang up if you can't get me help now. To accept this call press zero.

To Record your own emergency message

1. Press and release the **MENU** button until the **RECORD MESSAGE** is shown.
2. Press and hold the **OK** button. Start your message directly after the signal tone and "VOICE" icon is flashing. While recording, keep at a distance of 15 cm from the telephone so that you can speak easily into the microphone on the upper side.
3. Release the **OK** button after you have finished your emergency message.
The message will now be played back automatically.

To Check the emergency message

You can check the emergency message at any time.

1. Press and release the **MENU** button until the **CHECK MESSAGE** is shown.
2. Then press the **OK** button to play back the message.

To Delete your own emergency message and revert to the pre-recorded message



If you have recorded your own message, you can delete this and by doing so revert to the pre-recording message. Note: As stated above, it is important to record a personalized message.

1. Press and release the **MENU** button until the **CHECK MESSAGE** is shown.
2. Then press the **OK** button to play back the message.
3. During the playback, press **DELETE** button. Your own message will be deleted and you will be using the pre-recorded greeting.

PHONE BOOK (Emergency Nos.)

IMPORTANT: We suggest you enter up to 10 telephone nos. you would like to have called in an emergency with just one (1) press of a button.

Note: The phone book allows you to enter, display, record the persons name and specify if this a telephone no. that is to be called in the units Emergency Help System as well as the sequence in which the telephone numbers will be called.

To use the phone book and enter the telephone numbers to be called and the sequence of calling, press  Exit button until the  phone book icon is displayed.



Storing telephone numbers in the phone book including emergency nos. to be called in an emergency. (You may enter more or less). The total phone book allows you up to 30 telephone numbers for convenient/Important and Emergency calling numbers.





Note: We suggest you enter up to 10 telephone numbers for the emergency function. It is important to duplicate the calling of 1st few locations of entered emergency nos. in the event a called no. is busy or cannot be reached.

Entering telephone numbers names and location (entering location 1 means that is the 1st no. to be called, 2 the 2nd etc). Important: Enter tel.#'s, exactly as you would dial call from where installed.

Note: You may have a telephone system where it is beneficial to put a pause (P) before dialing a particular digit. Pressing the REDIAL button will create a 3.6 second pause (P). This is important if you are using on a PABX or PBX system where you should put a pause(P) before and after entering 1,8 or 9, or using the Emergency Help System of this unit.

For PBX or PABX users, enter a pause(P) before and after entering a 1, 8 or 9 to get outside dial tone.

1. Press and release the MENU button until STORE NUMBER is shown.
2. Press the **OK** button. The cursor will flash in the first position.
3. Enter the required telephone number exactly as you would dial it manually from the location where it is to be used. Enter the tel. no. with a maximum of 21 digits using the number pad and confirm with **OK** button, (both the erase feature and pause feature can be used when storing the telephone number).
4. Enter the required name with a maximum of 16 letters. Cursor shown as (I) is all the way on left side of the LCD display.
See Table 1 for details.
5. Confirm with **OK** button. The display now shows **EMERGENCY OFF**.
6. Scroll the  or  buttons to **EMERGENCY ON**.
7. Press **OK** button to confirm.

Now "**LOCATION**" is shown. Select the required location by scrolling  or  buttons and confirm with **OK** button, if the location you chose is in use, LCD display will show **OVERWRITE?**, confirm with **OK** or select another location with  or  buttons. Press the **OK** button and "**SAVED!**" is shown.

Note: Any telephone # entered that is to be used for emergency calling should be entered in the order those phone numbers are to be called.

Selecting the correct location is very important because this feature determines in case of emergency the sequence of the telephone numbers that will be dialed in the emergency feature. Location 1 will be dialed first, then 2, then 3 etc.

Important: if you choose to overwrite a location, the previously stored number will be erased.

The unit announces "Name Recording for Phone book",  icon on LCD display is shown. That means the phone number can be called in the Emergency Help System.

To record the voice (example: John), hold down **OK** button, speak clearly into microphone after a beep and "VOICE" icon is flashing. Release the button when you are finished, the unit will stop recording after 3 seconds. The recorded name will then be played automatically. [Recording the Voice is necessary for the personalized talking Caller ID and talking phone book feature]

8. Repeat step 1 to 6 to enter more emergency no, or press **⏏** (Exit) button to exit.

How to enter names in the phone book

The number buttons are also inscribed with letters for entering the name. **By repeatedly pressing the appropriate button, upper case letters as well as numbers and special characters can be entered.**

Overview: Note: In entering a name

Note: The numeric keys 1 thru # can be used as shown in Table I

1	space + & - / 1
2	A B C 2
3	D E F 3
4	G H I 4
5	J K L 5
6	M N O 6
7	P Q R S 7
8	T U V 8
9	W X Y Z 9
0	, . : ; ? 0
*	' @ () *
#	\$ _ % ! #

Example:

To enter the name JIM. Press 5 button until **J** is displayed Wait 2 seconds
 Press 4 button until **I** is shown Wait 2 seconds
 Press 6 button until **M** is shown Wait 2 seconds

TABLE I

Notes: Incorrect entries can be deleted with **DELETE** button. To do this, move the cursor by scrolling **△** or **▽** buttons and then press **DELETE** button.

When you place a pause in a telephone number...press redial button and a P will display.

To review the Phone Book Memory (All telephone nos. including Emergency Nos. and their location)

1. Press and release **⏏** (Exit) button, **📖** phone book icon is shown.
2. Review the stored phone number by scrolling **△** or **▽** buttons, or enter the initial letter of the name of the person you wish to call using the number pad. After a short time, the display will show the first stored telephone number with this initial letter, say the name and VOICE icon is shown if it was recorded, or voice the telephone number. You can now search for further numbers under this letter by scrolling **▽** button.

Notes:

- If no telephone number is stored, the display will show **EMPTY**.
- After you view all the call in memory, the display will show **END OF LIST**.
- If you review a number shown with **☎** icon on the LCD display, that means the number can be an emergency's call dial out.

If no key is pressed for 60 seconds, the telephone will return to standby Caller ID mode.

To dial and check a displayed emergency telephone number from the Phone Book Memory:

1. Pick up the handset or press **SPEAKER** button (the speaker LED will light) and wait for a dial tone.
2. Press and release **Exit** button, **Phone Book** icon is shown.
3. Scroll to desired tel. no. with **+** icon on the LCD display by scrolling **△** or **▽** buttons.
4. Press **OK** button, Unit will dial telephone no.
5. If you desire you can speak to called party and explain that you are adding their telephone number to your Telemergency Emergency Help System.

IMPORTANT: Follow all Cautions below if Emergency Help System is to be activated. If you are using the Emergency Help System and wish to call "911" or other emergency services which have a dispatcher, the following procedures should be followed. Note: Check with your local "911" and/or other emergency services and verify the use of their no. in your area.

WHEN PROGRAMMING EMERGENCY NUMBERS AND(OR) MAKING TEST CALLS TO EMERGENCY NUMBERS:

1. Remain on the line and briefly explain to the dispatcher the reason for the call.
2. Perform such activities in the off-peak hours, such as early morning or late evenings.

Caution - To ensure proper operation, this equipment must be installed according to the enclosed installation instructions. To verify that the equipment is operating properly and can successfully report an alarm, this equipment must be tested immediately after installation, and periodically thereafter, according to the enclosed test instructions.

Caution - This equipment cannot report an alarm when other equipment (telephone, answering system, computer modem, etc.) connected to the same phone line is in use.

Recording / Editing / Deleting voice prompt of name of phone book

With caller ID service activated, when an incoming call is received, the unit will display and announce the caller's phone number. If the caller's phone number is stored in the phone book, and caller's name will be displayed too.

If the voice prompt is recorded for this phone number, the unit will announce the voice prompt recorded instead of the caller's phone number.

1. Press and release the **MENU** button until the "**NAME RECORDING**" is shown.
2. Press the **OK** button. A list of the phone book entries will be display.
3. Scroll **△** or **▽** buttons to select the list you like to record a voice or name for it.
4. To record or edit the voice prompt, hold down **OK** button. Speak clearly into the microphone after a beep and "**VOICE**" icon is flashing. Release the button when you finished or the unit will stop recording after 3 seconds. The new voice prompt will then be played automatically.
To delete the voice prompt recorded, press **DELETE** button during the voice prompt is playing.
5. Repeat step 3 to 4 to edit or delete more entry or exit the set-up mode by pressing the **Exit** button.

To Edit the Phone Book Memory

1. Press and release **EXIT** (Exit) button, **PHONE BOOK** icon is shown.
2. Select the required location from the phone book by scrolling **UP** or **DOWN** buttons.
3. Press and hold **MENU** button for two seconds. The display will show **EDIT?**.
4. Press **OK** button, the first digit of the selected phone number will be flash.
5. You can move the cursor to the required position by scrolling **UP** or **DOWN** buttons. To delete the digit, press **DELETE** button, or press any numeric key to replace the digit and confirm with **OK** button. Then the display shows the flashing first letter of the name.
6. Move the cursor to the required position by scrolling **UP** or **DOWN** buttons. To delete the letter, press **DELETE** button, or press any numeric key to replace the name, and confirm with **OK** button, "**EMERGENCY ON or OFF**" is shown.
7. If the display shows "**EMERGENCY OFF**", and you want to change it as an emergency's call dial out, select "**EMERGENCY ON**" by scrolling **UP** or **DOWN** buttons, and confirm with **OK** button, now "**LOCATION**" is shown. Select the required location by scrolling **UP** or **DOWN** buttons and confirm with **OK** button, if the location is in use, now display shows **OVERWRITE?**, confirm with **OK**, "**SAVED!**" is shown.
 - If you select "**EMERGENCY OFF**" and confirm with **OK**, "**SAVED!**" is shown.
8. You can repeat step 2 to 7 to edit more numbers or press **EXIT** (Exit) button to exit.

To Delete the Phone Book Memory

1. Press and release **EXIT** (Exit) button, **PHONE BOOK** icon is shown.
2. Select the required location from the phone book by scrolling **UP** or **DOWN** buttons.
3. To delete single memory, press **DELETE** button once. The display will show the **DELETE?**. Press **DELETE** button for 2 seconds. The telephone number and name will be deleted and the display will now show another number from the phone book.
To delete all entire memory, press and hold **DELETE** button until the display shows **DELETE ALL?**. Press **DELETE** button for 2 seconds until **EMPTY** appears on the display.

To Store Numbers hotkey **EMERGENCY 1** and **EMERGENCY 2** (User programmable)

The phone is equipped with two emergency hot keys. They can be programmed with the telephone number of the police or the fire department or any other emergency number for each of these buttons. These two buttons are not part of the phone book. They are quick dial telephone numbers that simply dial the telephone number you pressed with just the press of that button.

1. Press and release the **MENU** button until the **STORE NUMBER** is shown.
2. Press the **OK** button. The cursor will flash in the first position.
3. Enter the required telephone number with a maximum of 22 digits using the number pad and confirm with **OK** button.
4. Press **EMERGENCY 1** or **EMERGENCY 2** buttons.
5. Confirm with **OK** button. The number has now been saved and display show **SAVED!**.
6. Repeat step 2 to 5 to store other numbers for other memory buttons or press **DELETE** button to exit.

To dial the numbers in the emergency **MEMORY** Buttons, simply pick up the handset or press **SPEAKER** button and press **EMERGENCY 1** or **EMERGENCY 2** buttons.

Note: The numbers stored in these 2 memory buttons are for manual dialing only and will not be dialed in the emergency feature unless they are also entered in the phone book and when entered are programmed in as an emergency no. and a specific location.

To Activate the Emergency Help System:

IMPORTANT: For the Emergency Help System to activate and also dial out the emergency telephone numbers entered in the desired sequence, as entered, requires that the telephone line ClearVoice 50A, 100A, or 200A is connected to is ON HOOK(hung up), and all instructions in setting up this important feature have been confirmed.

1. Press and hold the **+** button on the telephone for 3 seconds, the NEW CALL LED on the telephone will blink for 15 seconds. The telephone local alarm sounds for 15 seconds. The telephone will then dial out the entered emergency help system numbers automatically in speakerphone mode.

Note: Using the dual wireless pendant (CV112). To activate the Emergency Help System with the dual pendant (CV112) press and hold down the red button on the pendant for 3 seconds until the pendant LED will begin flashing. The pendant will flash for approximately 15 seconds. This will activate the Emergency Help System if user is within the operating range of the unit. Note: If user holds the red pendant button for 8 seconds or more and is in the operating range of the unit, the Emergency Help System will turn off and reset. The LED on pendant should stop flashing and its LED to remain lit for approximately 5 seconds. User must be in operating range of unit.

Note: To turn off the Emergency Help System if activated, simply press the Speakerphone button. and note that the speakerphone LED will turn off or pick up handset of unit to turn off Emergency Help System and speak to called party, if on the line. Then hang up telephone (ON HOOK) to reset.

2. The telephone dials out the first of the entered emergency numbers (stored in the phone book emergency location1) in speakerphone mode, and then begins playing the emergency message.

If during the period the emergency message is played (if available to the called party), called party can acknowledge the call by pressing **0**, the telephone will be put in speakerphone operation for 1 minute. After 1 minute, the phone beeps loudly for 7 seconds. If within these 7 seconds, the called party presses a numeric key on the phone, the unit will be kept in speakerphone mode for 1 additional minute continuously without stopping. If any numeric key on the phone is not pressed during the 7 seconds, the call to the called party is disconnected.

Note: If 0 is not pressed during the period the message is played, the next emergency number in the sequence will be dialed automatically in speakerphone mode.

Important Information about ClearVoice 50A,100A or 200A Emergency Help System:

Note: A tone dialing telephone is required for a called party(s) to be able to respond to a message received from the Emergency Help System.

1. If NO emergency numbers have been entered, the telephone will not dial any no. and just beep loudly for 15 seconds continuously when the emergency (**+**) button on the telephone, is pressed and held for more than 3 seconds or on the red button on CV112 dual pendant (standard on the ClearVoice 200A™) is pressed for 3 seconds. If red pendant button is pressed and held for 8 seconds or more continuously, the emergency process will stop and reset.
2. It is important that the CV 112 pendant must be within the range of the telephone to activate the emergency feature.

3. When the red key on the optional pendant (standard on the ClearVoice 200A™) is pressed and held for 3-5 seconds, the LED on the pendant will begin flashing and if the pendant is pressed for 8 seconds the LED will simply stay ON for approximately five (5) seconds letting user know that the Emergency Help System has been turned off and reset.
To activate the Emergency Help system is simple. Simply press and hold down red button until LED flashes on the pendant. Then release button. This LED will stay lit for 15 seconds.
4. To stop the already activated emergency help system, turn off speakerphone by pressing the speakerphone button or if using the dual pendant (CV112). Press the red button on pendant for more than 8 seconds. LED will stop flashing and remain on for approximately 5 seconds.
5. If a called party presses 0 on their tone dialing telephone after hearing the emergency message, the emergency speakerphone feature will be activated allowing the called party to speak to the caller, and the caller can respond (if near or able) for up to 1 minute if in the speakerphone of the ClearVoice 50A, 100A or 200A. After 1 minute beeps will be heard for 7 seconds and to continue either party can press any key on their numeric keypad for the call to continue for another minute.
6. **The emergency help system will automatically stop dialing the entered emergency numbers if all the emergency nos. have been dialed or if any person who has received the emergency call presses 1 then 2 on their tone dialing phones numeric keypad after the 0 key has been pressed.**
7. Do not pick up handset of ClearVoice 200A if the Emergency Help System has been activated, the speakerphone is active. Lifting the handset will deactivate the Emergency Help System.
8. There is an optional CV112 dual pendant that can be purchased for the ClearVoice 50A or 100A models (standard on the ClearVoice 200A™). This feature is important for those who are concerned with falling or are concerned that they can't get to the telephone in an emergency. For more information.. call our Consumer Helpline 1-888-558-7420.

Checking the Range of the Dual Wireless Help Pendant (CV112)

Note: The typical range can operate up to 100 feet line of sight. This range may be reduced by structural or environmental conditions.

Follow all installation instructions. Before checking the range remove the telephone line cord where it is marked TEL.LINE located at the back of the unit.

Press and hold the red button on the pendant until the LED on pendant begins flashing (from the farthest place you will be using the pendant within the above criteria). If within range, The Emergency Help System will be activated and you will hear the local alarm from unit. To stop the unit from dialing emergency numbers.

Press and hold the red button for 8 seconds until the LED stops flashing and remains steady ON for approximately 5 seconds. The CV112 pendant should be used at a reduced range .

Note: If you are out of range of the unit, move closer and follow the directions.

IMPORTANT: Install the telephone line cord to where it is marked TEL.LINE located at the back of the unit.

To verify you reconnected the telephone line cord.. press speakerphone button until you hear dial tone, then press speakerphone button again to turn off.

THE CALLER ID

At each incoming call with available Caller ID, the telephone will ring and announce the caller with their name (if entered in phone book with name recording and matching last 7 digits of incoming phone no. shown on LCD display), if available, or with a voiced telephone number if available.

Important: When using the Caller ID features, please note it is only available at Caller ID mode (CLIP icon turns on). If the CLIP icon is off, press  (Exit) button once.

Please note that all Caller ID features are strictly related to the service provided by the provider of your telephone services. It is necessary to subscribe to the caller id service supplying service to your home to have the features of who is calling or telephone 3s on incoming calls. Even if you don't have Caller ID service you can enjoy the many features, since if you have an answering machine, you can hear who is calling and decide to pick up call if you desire.

If the telephone is connected to a PABX the caller ID features depend on the PABX.

The Caller ID feature is only possible with the unit powered by the 120V AC power supplied to your unit through the AC Adaptor enclosed with your unit or by the backup batteries in case of power failure(s) for a total time of up to 12 hours of power failure time.

Receiving a Call (the telephone can store up to 64 calls)

- If only the caller's phone number is received, the display shows the caller's phone number with the time and date it was received. The NEW icon turns on and NEW CALL LED blinks.

Notes:

1. CALL#01 means this data is stored in Caller ID memory location #01.
 2. The calling time and date are immediately recorded from the real-time clock.
- If both the caller's name and phone number are received, the display shows the caller's name and phone number, with the time and date it was received. The "NEW" icon turns on and NEW CALL LED blinks.
Note: If the caller's name has more than 16 characters, only the first 16 characters will be displayed.
 - If the name and number are not available due to the caller's restriction, the display shows **-PRIVATE CALL-** with the time and date received. The NEW icon turns on and NEW CALL LED blinks.
 - If the name and number are not available, the display will show **-OUT OF AREA-** with the call's time and date. The NEW icon turns on and NEW CALL LED blinks.
 - If a long distance call message is received, the display will show **-LONG DISTANCE-** with the calls time and date. The NEW icon turns on and NEW CALL LED blinks.
 - If an incorrect, invalid or incomplete Caller ID signal is received, the display shows **-NO NUMBER-**.

NOTES:

1. If the Caller ID memory is full, the oldest data will be removed on a first-in/first-out basis.
2. If the Caller ID information received duplicates another call in memory, the time/date will be updated and the "REPEAT" icon will be lit.
3. If no key is pressed within 60 seconds, the display will display the total call counter, new call counter, current time and date.

Viewing the Caller ID Memory

Press and scroll ▾ button to review more recent calls. The CALL# will increase.
After you view the most recent data in memory, the display will show **END OF LIST**.

Press and scroll ▲ button to review older calls. The CALL# will decrease.
After you view the oldest data in memory, the display will show **END OF LIST**.

If the data in memory is being reviewed for the first time, the NEW icon will be lit.
The NEW CALL LED will turn off if you review the data.

If no key is pressed within 20 seconds, the display will display the total call counter, new call counter, current time and date.

Erase the Caller ID Memory

1. Select the required Caller ID memory location by scrolling the ▲ or ▾ buttons.
2. *To delete single memory*, press **DELETE** button once. The display will show the **DELETE?**. Press **DELETE** button for 2 seconds. The data for that call will be erased, and the CALL# and Caller ID information will be updated.
To delete all entire memory, press and hold **DELETE** button until the display shows **DELETE ALL?**. Press **DELETE** for 2 seconds until **NO CALLS** appears on the display. Both the total call and new call counters will become zero, and the current time and date will be displayed.

Call Back (Redial) from the Caller ID Memory

With the ClearVoice 50A, 100A or 200A hung up (ON HOOK) Select the required Caller ID memory location by scrolling ▲ or ▾ buttons.

Press **OK** button two times, the speakerphone will turn on automatically and dial the selected number.

OR

With the handset picked up, select the required Caller ID memory location by scrolling ▲ or ▾ buttons, then press **OK** button, press **OK** again.

Note: If the Caller ID number is 10 digits, press OK button once, the unit will insert "1" before the Caller ID number automatically. You can press ▾ button to select insert "1" or not. Press OK again, the speakerphone will turn on automatically and dial the display number.

Copy from the Caller ID to the Phone Book

You can copy Caller ID information to the phone book while you are reviewing the Caller ID information.

1. Select the required Caller ID memory location by scrolling ▲ or ▾ buttons.
2. Press and hold MENU button for two seconds, display will show **COPY TO MEMORY?**.
2. Press **OK** button, display will show **SAVED!**.

IMPORTANT REVIEW

DO NOT:

- Connect to coin operated telephone systems
- Connect to party line telephone systems
- Connect to electronic key telephone systems

IN CASE OF DIFFICULTY

SITUATION	ACTION
The LCD can not be seen clearly	Modify the LCD contrast setting (see paragraph)
The telephone does not dial	Check your telephone line connection
The telephone can not perform any of the features	Check your AC Power connection
The optional pendant(CV100A) does not pick up an incoming call	Replace the 4 AA alkaline batteries in the unit.
The pendant can not activate the emergency feature (CV200A)	Batteries in the pendant might require replacing
The optional CV200A pendant doesn't activate the Emergency Help System	Move closer to unit. Also, when checking the range of the pendant, if the LED display is weaker or the range has been reduced, replace the batteries in the pendant.
The called party can not hear well during speakerphone conversation or during the speakerphone emergency call	It is necessary to move closer to the telephone and speak in the direction of the telephone.
The automatic voice feature does not work	You might have programmed VOICE OFF in the menu. Change the setting to Voice ON
	The speaker volume is too low. Increase the speaker volume <small>SPEAKER VOLUME</small>
Talking Caller ID does not work	Check that the caller id service is being provided by your telephone operator
	For the talking caller ID it is necessary to have VOICE ON in the programming.
Reset procedure	Reset the unit by removing the power supply, the batteries and the telephone line for 20 minutes and then power on again.
	This procedure will not erase any of the numbers in memory or of the user recorded messages.

LIMITED NINETY-DAY WARRANTY

This product is warranted by Telemergency, Ltd. against manufacturing defects in material and workmanship under normal use for ninety (90) days from the date of purchase. EXCEPT AS PROVIDED HEREIN, TELEMERGENCY, LTD. MAKES NO EXPRESS WARRANTIES AND ANY IMPLIED WARRANTIES, INCLUDING THOSE OF MERCHANTABILITY AND FITNESS FOR A PARTICULAR PURPOSE, ARE LIMITED IN DURATION TO THE DURATION OF THE WRITTEN LIMITED WARRANTIES CONTAINED HEREIN. EXCEPT AS PROVIDED HEREIN, TELEMERGENCY, LTD. SHALL HAVE NO LIABILITY OR RESPONSIBILITY TO CUSTOMER OR ANY OTHER PERSON OR ENTITY WITH RESPECT TO ANY LIABILITY, LOSS OR DAMAGE CAUSED DIRECTLY OR INDIRECTLY BY USE OR PERFORMANCE OF THE PRODUCT OR ARISING OUT OF ANY BREACH OF THIS WARRANTY, INCLUDING, BUT NOT LIMITED TO, ANY DAMAGES RESULTING FROM INCONVENIENCE, LOSS OF TIME, DATA, PROPERTY, REVENUE, OR PROFIT OR ANY INDIRECT, SPECIAL, INCIDENTAL OR CONSEQUENTIAL DAMAGES, EVEN IF TELEMERGENCY, LTD. HAS BEEN ADVISED OF THE POSSIBILITY OF SUCH DAMAGES.

Some states do not allow the limitations on how long an implied warranty lasts or the exclusion of incidental or consequential damages, so the above limitations, or exclusions may not apply to you. In the event of a product defect during the warranty period, contact Telemergency, Ltd. For a Returned Merchandise Authorization. Telemergency, Ltd. will, at its option, unless otherwise provided by law: (a) correct the defect by product repair without charge for parts and labor; (b) replace the product with one of the same or similar design; or (c) refund the purchase price. All replaced parts and products on which a refund is made, become the property of Telemergency, Ltd. New or reconditioned parts and products may be used in the performance of warranty service.

Repaired or replaced parts and products are warranted for the remainder of the original warranty period. You will be charged for repair or replacement of the product made after the expiration of the warranty period.

This warranty does not cover: (a) damage or failure caused by or attributable to acts of God, abuse, accident, misuse, improper or abnormal usage, failure to follow instructions, improper installation or maintenance, alteration, lightning or other incidence of excess voltage or current; (b) any repairs other than those provided by Telemergency, Ltd; (c) consumables such as fuses or batteries; (d) cosmetic damage; (e) transportation, shipping or insurance costs; or (f) costs of product removal, installation, set-up service adjustment or reinstallation.

This warranty gives you specific legal rights, and you may also have other rights which vary from state to state.

Telemergency Ltd., Customer Relations, Dep't. R, 200 13th Avenue, Suite 16B2, Ronkonkoma, New York 11779

THE FEATURE ORIENTED PHONE SYSTEM FOR EVERY HOME

With exclusive Emergency Help System
you can Call-4-Help with a press of a button

Hear who is calling
before you decide to answer an incoming phone call*

Answer your phone and speak hands-free
even if you can't get to the phone**

QUICK INSTRUCTION GUIDE

ClearVoice 50 A™

ClearVoice 100 A™

ClearVoice 200 A™

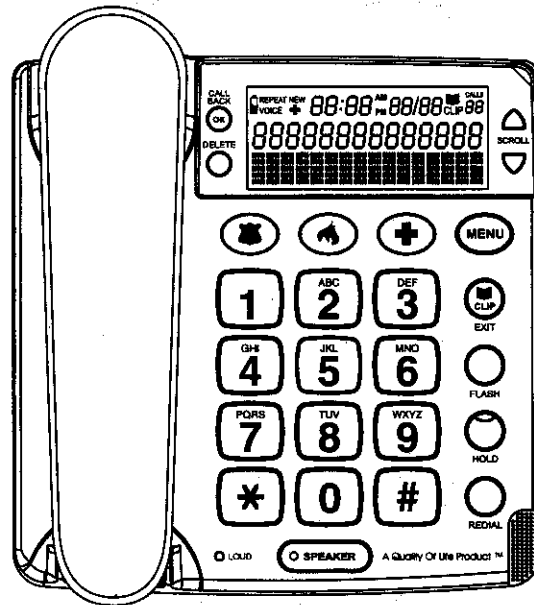

Consumer Helpline **1-888-558-7420**

IMPORTANT: PLEASE READ USER MANUAL BEFORE PROCEEDING

LOCATION OF CONTROLS

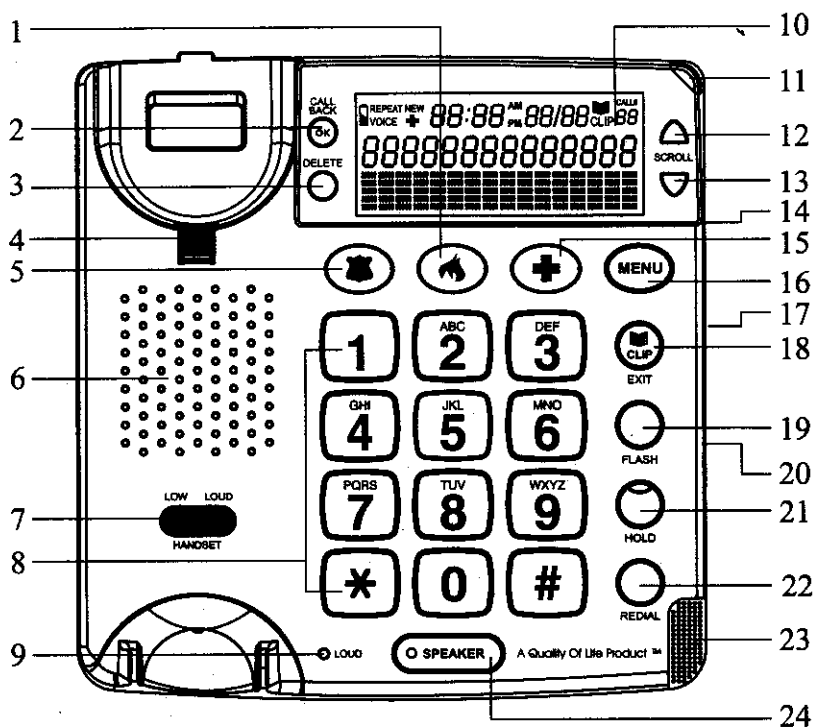

- | | |
|---------------------------|-----------------------------|
| 1. button | 14. Ringer Hi/Mid/Lo switch |
| 2. CALL BACK / OK button | 15. + button |
| 3. DELETE button | 16. MENU button |
| 4. Handset Holder | 17. Tone Hi/Lo switch |
| 5. button | 18. (Exit) button |
| 6. Speaker | 19. FLASH button |
| 7. Handset volume control | 20. switch |
| 8. Dial keypad | 21. HOLD button |
| 9. Loud LED | 22. REDIAL button |
| 10. Display | 23. Ringer LED |
| 11. New Call LED | 24. SPEAKER button with LED |
| 12. button | 25. Pendant button |
| 13. button | 26. Pendant LED |

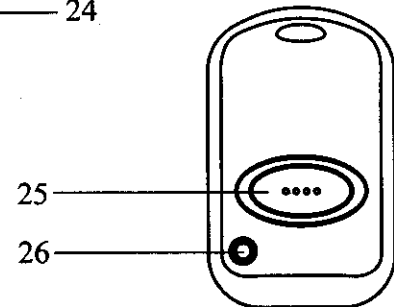

OPTIONAL
PENDANT

INSTALLATION

Choose your location

Your ClearVoice 50A, 100A or 200A must be placed on a hard surface and connected to both the telephone wall jack and an AC power source. Allow at least one inch to the rear and four inches above the unit for ventilation. If you have a ClearVoice 100A or 200A, we suggest you locate it in a location within 10 feet of where user spends much of his time.

For users of ClearVoice 100A or 200A: You can activate the speakerphone on an incoming call of the ClearVoice 100A or 200A remotely. You can typically speak from up to 10-15 feet from the phone which should be in direct line of sight. Speaking louder can allow you to speak up to 20 feet, line of sight.

For users of ClearVoice 200A: The ClearVoice 200A is supplied with a dual pendant which can activate the speakerphone, but also can activate the emergency mode from a distance of up to 80 feet. This range may be reduced by structural or environmental conditions.

For users of ClearVoice 50A and 100A: You can purchase accessory(s) which can activate both the speakerphone for incoming calls as well as activating the Emergency Help System.

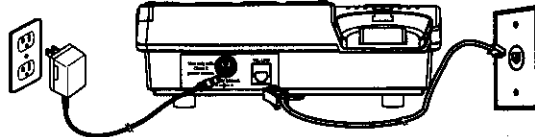

To retain full operation of ClearVoice 50A, 100A and 200A, during power failures insert 4 AA batteries (not included) into the battery compartment located at bottom of unit. You may do this by simply disconnecting the AC adaptor from the power source, then removing the battery cover, connecting the batteries and replacing the cover. Then immediately connect AC Adaptor to AC outlet to assure battery life is not being affected. Note: The AA batteries should be alkaline.

Connecting the ClearVoice 50A, 100A or 200A:

1. A. Plug one end of the supplied telephone cord into the jack labeled TEL LINE located at the back of the unit.
B. Plug the other end of the supplied modular cord into the telephone wall jack.
2. A. Plug the supplied power cord of the AC Adaptor into the jack labeled DC9V 200ma located on the back of the unit.
B. Plug the other end of the power cord into an electrical outlet **not controlled by a wall switch**.

Wall Mounting

On a Wall Phone Plate

1. Press and lift out the handset holder. Rotate it 180°, and snap it into place so it will hold the handset in place when the phone is mounted on the wall.
2. Insert the mounting bracket's two tabs into the matching slots opposite the keyhole slot on the underside phone's base. Then press down and slide the bracket upward until the tabs snap into place.
3. Plug one end of the supplied short modular cord into the LINE jack at the back of the base.
4. Plug the cord's other end into the wall plate jack, then align the base's keyhole slots with the wall plate studs and slide the phone downward to secure it.

On a Wall Without a Plate

To mount the phone directly on a wall, in addition to the preceding steps, you need two screws (not supplied) with heads that fit into the keyhole slot on the bottom of the base.

1. Drill two holes 83mm apart (vertically). Then thread a screw into each hole, letting the heads extend about 5mm from the wall.
2. Substitute the long modular cord for the short cord.

Place
Stamp
Here

TELEMERGENCY™

TELEMERGENCY LTD.
200-16B2 13th Avenue
Ronkonkoma, New York 11779

TELEMERGENCY, LTD.
Warranty Registration Card

*Please complete and return this card
immediately to register your product.*

Mr. Ms. Name:.....
Address:.....
City:.....State:.....Zip:.....
Is this a residence? Home office? Other?
Phone #: ().....Fax: ().....
E-mail address:.....
Name of store where purchased:.....
Location:.....Date of Purchase:.....
Model:.....Serial No.:.....

USING THE TELEPHONE

Dialling a Call

1. Pick up the handset or press **SPEAKER** button (the speaker LED will light) and wait for a dial tone.
2. Press the keypad for the telephone numbers you wish to dial. The display will show the number that you dialed on the keypad. If you dial a number over 14 digits long, it will show the last 14 digits only.
3. When you have completed your call, hang up the handset, or press **SPEAKER** button again.

To switch from a handset conversation to a speakerphone conversation press the **SPEAKER** button and hang up the handset. To switch from speakerphone to handset, simply pick up handset.

Pre Dialling a Call (Hearing each digit entered before dialling)

1. Dial on the keypad the telephone number. The telephone will voice the digits dialed (with voice option ON). To correct a number press the **DELETE** button for each incorrect digit.
2. Pick up the handset or press **SPEAKER** button.

Receiving a Call

When you receive a call, the telephone rings, the Ringer LED flashes and the display shows the CALL# and the caller telephone number, and will state the name of the caller if the number matches with a name recorded in the phone book, if not, it will say the numbers of the calling party if available (Caller ID service required). Caller ID service required to detect Call# and/or name of caller.

This feature allows you to decide to pick up the phone or not depending on who is calling.

If you want to talk to the caller:

1. Pick up the handset or press **SPEAKER** button to answer the call.
2. At the end of the call, return the handset to the cradle or press **SPEAKER** button again to disconnect.

Receiving a Call/Speakerphone remotely (Models 100 and 200)

Simply press the red button on the CV111 or CV112 pendant for 1 second to connect the call and activate its speakerphone if you hear the phone, but can't get to the telephone.

When you are near the speakerphone you can begin speaking to the caller without picking up the handset. To terminate the call, press the red button again for 1 second.

Note: A feature is included if you activated the speakerphone with the wireless pendant (ClearVoice 100 or 200 pendant), and forgot to disconnect the phone. In this way, the speakerphone can turn OFF. After 15 minutes, the phone will beep for 7 seconds. If within these 7 seconds the called party presses any numeric key on the phone, the unit will be kept in speakerphone mode conversation for 1 minute continuously. If no numeric key on the phone is pressed during the 7 seconds, the telephone will deactivate the speakerphone and return to standby mode unless you pick up your handset on the ClearVoice 100 or 200 to continue.

This convenience feature is particularly useful if you are sitting on a couch, busy doing something else, can't get to the phone on time and don't want to miss the call.

USING THE PHONE BOOK

follow pages 14 thru 16 of the USER MANUAL

USING EMERGENCY FEATURES

follow pages 17 thru 23 of the USER MANUAL

USING THE CALLER ID

follow pages 24 thru 25 of the USER MANUAL

Telemergency Ltd.
200 13th Ave., Ronkonkoma, N.Y. 11779